

REV.	DESCRIPTION	ECN NO.	DATE	DRAWER
A	New Release		12/19/2005	Alan

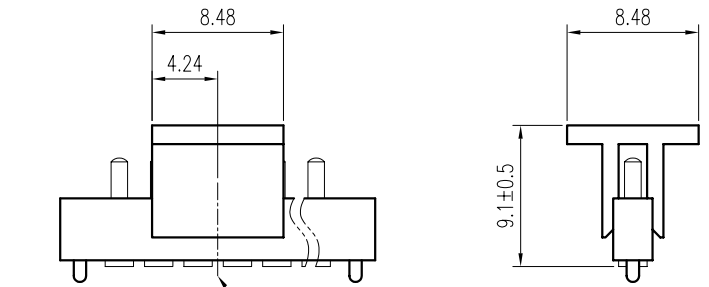
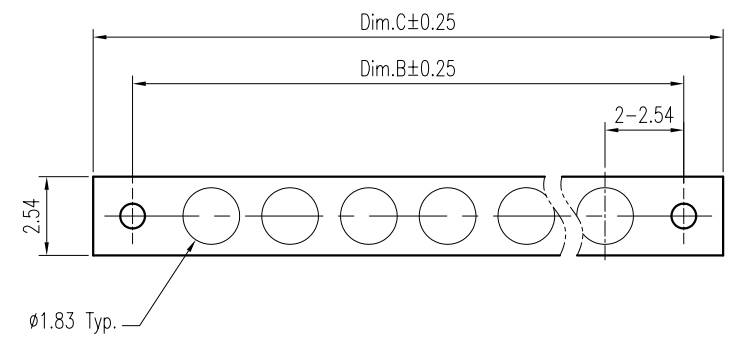
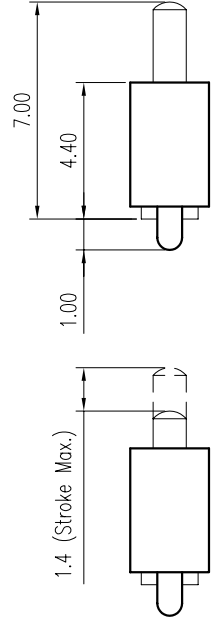
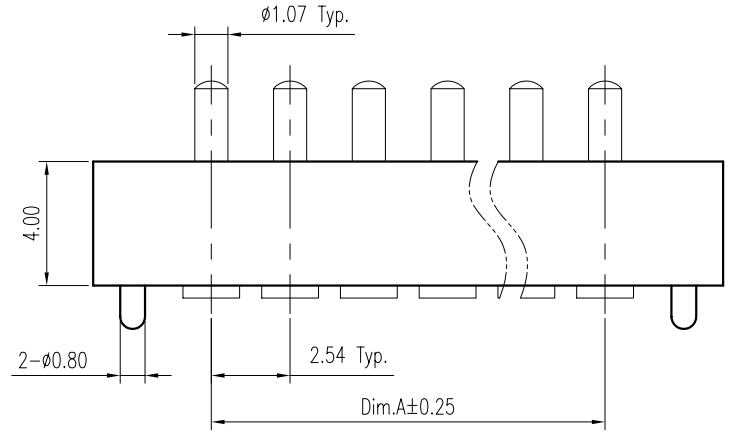

With Cap
Scale 2 : 1

Notes:

- Material :
Housing : Thermoplastic UL 94V-0
Terminal : Copper Alloy
Cap: Thermoplastic UL 94V-0
- Finish :
Terminal : 20u" Gold on Contact Area, 10u" Gold on Solder Tails, Both over 100u" Ni Under-plated Overall
- Stroke 1.4mm Max.
- Order Information :

T	PE1-011	X	8-0	X	X	1
T :	RoHS					
						Packing
						T : Tube
						1 : Tube With Cap
						Color
						1 : White
						2 : Black

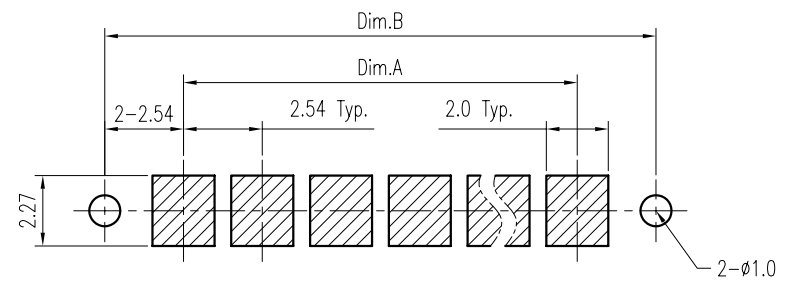

Recommended P.C.B. Layout
Layout Tolerance = ± 0.05 mm

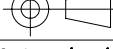
DIMENSION IN mm [inch]		 欣訊科技股份有限公司 CEN LINK CO., LTD.	Title 2.54mm Pitch Pin Header (Spring Pin)		 Scale: 4 : 1
Tolerance unless otherwise specified			Dwg No. TPE1-011X8-OXX1		
X. ± 0.50	X.* ± 10'	CUSTOMER DRAWING		File No. P01008	Rev : A
X.X ± 0.38	X.X* ± 5'	Approver:		Drawer: Alan	Sheet: 1 / 1
X.XX ± 0.25	X.XX* ± 2'	Checker:		12/19/2005	
X.XXX ±	X.XXX* ±				