

REV.	DESCRIPTION	ECN NO.	DATE	DRAWER
A	New Release		11/11/2005	Aaron

Notes:

- Material :
Housing : Thermoplastic UL 94V-0
Terminal : Copper Alloy
- Finish :
Terminal : 20u" Gold on Contact Area, 10u" Gold on Solder Tails, Both over 100u" Ni Under-plated Overall

3. Order Information :

T PE1-011 X 2-0 X X 1

T : RoHS(for High Temperature)

Pins :

- 2 : 2 Pins
- ?
- 9 : 9 Pins
- A : 10 Pins
- ?
- G : 16 Pins

Color :

- 1 : White
- 2 : Black

Packing :

- T : Tube
- 1 : Tube + Cap

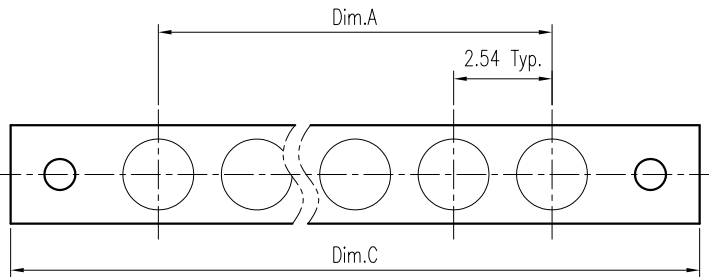
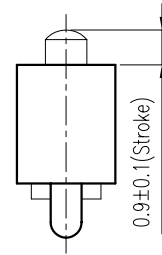
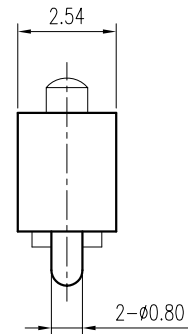
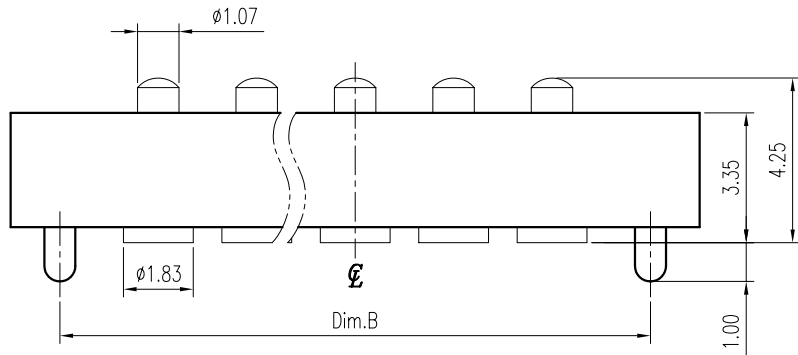

Dimension Information:

Part No.	Dim.	Pins	Dim.A	Dim.B	Dim.C
TPE1-01122-OXX1	2	2.54	7.62	10.16	12.70
TPE1-01132-OXX1	3	5.08	10.16	12.70	15.24
TPE1-01142-OXX1	4	7.62	12.70	15.24	17.78
TPE1-01152-OXX1	5	10.16	15.24	17.78	20.32
TPE1-01162-OXX1	6	12.70	17.78	20.32	22.86
TPE1-01172-OXX1	7	15.24	20.32	22.86	25.40
TPE1-01182-OXX1	8	17.78	22.86	25.40	27.94
TPE1-01192-OXX1	9	20.32	25.40	27.94	30.48
TPE1-011A2-OXX1	10	22.86	27.94	30.48	33.02
TPE1-011B2-OXX1	11	25.40	30.48	33.02	35.56
TPE1-011C2-OXX1	12	27.94	33.02	35.56	38.10
TPE1-011D2-OXX1	13	30.48	35.56	38.10	40.64
TPE1-011E2-OXX1	14	33.02	38.10	40.64	43.18
TPE1-011F2-OXX1	15	35.56	40.64	43.18	45.72
TPE1-011G2-OXX1	16	38.10	43.18	45.72	

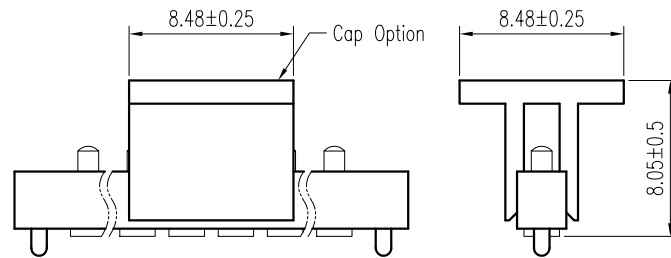

With Cap
Scale 2.5:1

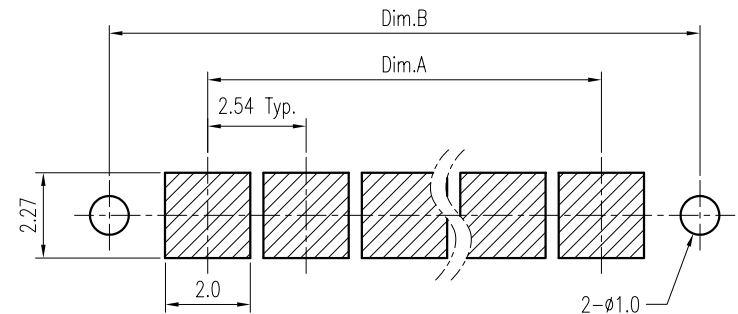

Recommended P.C.B. Layout
Layout Tolerance = ± 0.05 mm

DIMENSION IN mm [inch]			
Tolerance unless otherwise specified			
X.	± --	X.*	± 10'
X.X	± 0.38	X.X*	± 5'
X.XX	± 0.25	X.XX*	± 2'
X.XXX	± 0.13	X.XXX*	± --

CEN 欣訊科技股份有限公司
CEN LINK CO., LTD.
CUSTOMER DRAWING

Approver:

Checker:

Drawer: **Aaron**

11/11/2005

Title 2.5mm Pitch Pin Header
Single Type

Dwg No. TPE1-011X2-OXX1

File No. PO1008

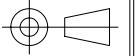

Scale: 5 : 1

Size: A 4

Rev : A

Sheet: 1 / 1